

Шкафы для безопасного хранения с вертикальными выдвигаемыми ящиками с электронным или ручным управлением V-LINE, V-MOVE-90, V-CLASSIC-90

Технические характеристики

По вопросам продаж и поддержки обращайтесь:

Алматы (727)345-47-04
Ангарск (3955)60-70-56
Архангельск (8182)63-90-72
Астрахань (8512)99-46-04
Барнаул (3852)73-04-60
Белгород (4722)40-23-64
Благовещенск (4162)22-76-07
Брянск (4832)59-03-52
Владивосток (423)249-28-31
Владикавказ (8672)28-90-48
Владимир (4922)49-43-18
Волгоград (844)278-03-48
Вологда (8172)26-41-59
Воронеж (473)204-51-73
Екатеринбург (343)384-55-89

Иваново (4932)77-34-06
Ижевск (3412)26-03-58
Иркутск (395)279-98-46
Казань (843)206-01-48
Калининград (4012)72-03-81
Калуга (4842)92-23-67
Кемерово (3842)65-04-62
Киров (8332)68-02-04
Коломна (4966)23-41-49
Кострома (4942)77-07-48
Краснодар (861)203-40-90
Красноярск (391)204-63-61
Курск (4712)77-13-04
Курган (3522)50-90-47
Липецк (4742)52-20-81

Магнитогорск (3519)55-03-13
Москва (495)268-04-70
Мурманск (8152)59-64-93
Набережные Челны (8552)20-53-41
Нижний Новгород (831)429-08-12
Новокузнецк (3843)20-46-81
Ноябрьск (3496)41-32-12
Новосибирск (383)227-86-73
Омск (3812)21-46-40
Орел (4862)44-53-42
Оренбург (3532)37-68-04
Пенза (8412)22-31-16
Петрозаводск (8142)55-98-37
Псков (8112)59-10-37
Пермь (342)205-81-47

Ростов-на-Дону (863)308-18-15
Рязань (4912)46-61-64
Самара (846)206-03-16
Санкт-Петербург (812)309-46-40
Саратов (845)249-38-78
Севастополь (8692)22-31-93
Саранск (8342)22-96-24
Симферополь (3652)67-13-56
Смоленск (4812)29-41-54
Сочи (862)225-72-31
Ставрополь (8652)20-65-13
Сургут (3462)77-98-35
Сыктывкар (8212)25-95-17
Тамбов (4752)50-40-97
Тверь (4822)63-31-35

Тольятти (8482)63-91-07
Томск (3822)98-41-53
Тула (4872)33-79-87
Тюмень (3452)66-21-18
Ульяновск (8422)24-23-59
Улан-Удэ (3012)59-97-51
Уфа (347)229-48-12
Хабаровск (4212)92-98-04
Чебоксары (8352)28-53-07
Челябинск (351)202-03-61
Череповец (8202)49-02-64
Чита (3022)38-34-83
Якутск (4112)23-90-97
Ярославль (4852)69-52-93

Россия +7(495)268-04-70

Казахстан +7(727)345-47-04

Беларусь +(375)257-127-884

Узбекистан +998(71)205-18-59

Киргизия +996(312)96-26-47

эл.почта: auj@nt-rt.ru || сайт: <https://asecos.nt-rt.ru/>

Overview

Safety storage cabinets type 90

V-MOVE-90 | model class with unicolour design and electronic vertical drawer with automatic closing system

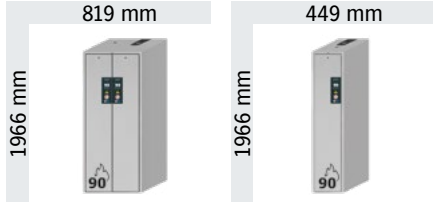

V90.196.081.VDAC:0012

page 38

V90.196.045.VDAC:0012

page 40

V-MOVE-90 | model class with bi-colour design and electronic vertical drawer with automatic closing system

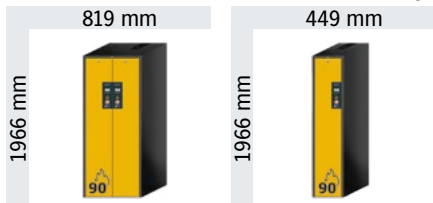

V90.196.081.VDAC:0013

page 38

V90.196.045.VDAC:0013

page 40

V-CLASSIC-90 | model class with vertical drawer, manual pull-out operation and vertical dividing wall

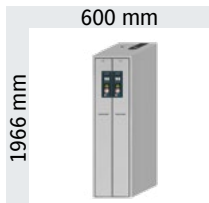

V90.196.060.MV.2VD:0012

page 44

V-LINE | V-MOVE-90

Safety storage cabinets for unrestricted storage of flammable hazardous materials in work areas in accordance with EN 14470-1 and TRGS 510

1

Optimum integration and use of space

With a depth of 86 cm, V-LINE cabinets now use the space next to laboratory fume cupboards and work benches that conventional hazardous material cabinets have left unused.

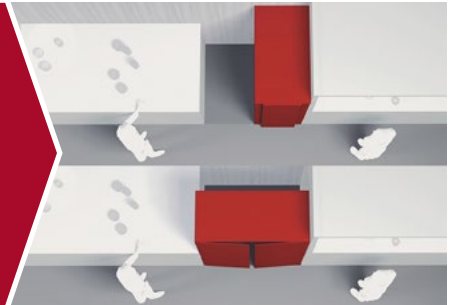

2

Maximum comfort

The vertical drawer technology allows access and visibility to all stored containers from both sides.



3

Innovative technology

At the push of a button the vertical drawers open and close automatically. The drawers glide softly and quietly out of and into the cabinet body, without additional physical efforts. The stop function of the vertical drawers detects resistances and eliminates the risk of being trapped



4

Modern colour design

Bi-colour design – choice of 5 door colours for the scratch proof surface
Unicolour design – choice of 2 colours for the powder-coated surface.



5

No unauthorised use

Doors lockable with cylinder lock; the cabinets can be integrated by the customer in an existing master key system. Locking status indicator (red/green) signals the locking status of the cabinet.



6

Technical ventilation

Integrated air ducts ready for connection (DN 75) to a technical exhaust system can be used for the extraction of hazardous substances vapours. The potential formation of explosive atmospheres or harmful vapours is safely prevented.



7

Guard rail system

For shelves as additional tilt protection for stored containers (optional).





- **Fire resistance of 90 minutes** (type 90), type-tested in accordance with EN 14470-1



- **GS-tested** (document EK5/AK4 09-10, ProdSG)



- Conformity in accordance with the requirements of **EN 16121** and **16122**
- Requirements and test methods for safety, strength, durability and stability.



- **Excellent products with special manufacturer warranty**
- Extended **manufacturer warranty of up to 10 years** in combination with an asecos service tariff
- Further information from page 512



V-LINE | V-MOVE-90



Model V90.196.081.VDAC:0012
Order No. 35035-001-35103



Model V90.196.081.VDAC:0013
Order No. 35086-051-35104





Model V90.196.081.VDAC:0012
Order No. 35035-005-35102

Technical data

External dimensions W x D x H	mm	819 x 860 x 1966
Internal dimensions W x D x H	mm	701 x 775 x 1750
Weight without interior equip.	kg	500
Air change 10 times	m ³ /h	9
Diff. pressure (air change 10 times EK5/AK4)	Pa	5
Max. load of drawers	kg	140
Power consump. in operation	W	50
Power consump. in standby mode	W	0,5
Nominal voltage	V	85-265



Main features

-  Space-saving design with high storage volume
-  Electronic vertical drawers for maximum ease of use
-  Visible storage

Model	Body colour	Door colour	Order No.
V90.196.081.VDAC:0013	anthracite grey RAL 7016	warning yellow RAL 1004	35086-040
		light grey RAL 7035	35086-041
		traffic red RAL 3020	35086-046
		gentian blue RAL 5010	35086-047
		stainless steel	35086-051
V90.196.081.VDAC:0012	light grey RAL 7035	light grey RAL 7035	35035-001
	laboratory white (sim. RAL 9016)	laboratory white (sim. RAL 9016)	35035-005

Interior equipment packages (can only be ordered in combination with the cabinet)	Material	Order No.
Left: 4x shelf, 1x perforated insert, 1x bottom collecting sump (V=12.5L) Right: 4x shelf, 1x perforated insert, 1x bottom collecting sump (V=12.5L)	powder-coated sheet steel RAL 7035	35102
Left: 5x shelf, 1x perforated insert, 1x bottom collecting sump (V=12.5L) Right: 5x shelf, 1x perforated insert, 1x bottom collecting sump (V=12.5L)	powder-coated sheet steel RAL 7035	35103
Left: 4x shelf, 1x perforated insert, 1x bottom collecting sump (V=12.5L) Right: 5x shelf, 1x perforated insert, 1x bottom collecting sump (V=12.5L)	powder-coated sheet steel RAL 7035	35104
Left: 4x tray shelf (V=6.0L), 1x bottom collecting sump (V=12.5L) Right: 4x tray shelf (V=6.0L), 1x bottom collecting sump (V=12.5L)	powder-coated sheet steel RAL 7035	36113
Left: 4x tray shelf (V=6.0L), 1x bottom collecting sump (V=12.5L) Right: 5x tray shelf (V=6.0L), 1x bottom collecting sump (V=12.5L)	powder-coated sheet steel RAL 7035	36114
Left: 5x tray shelf (V=6.0L), 1x bottom collecting sump (V=12.5L) Right: 5x tray shelf (V=6.0L), 1x bottom collecting sump (V=12.5L)	powder-coated sheet steel RAL 7035	36115

Accessories for these cabinet models:

Accessories	Material	W x D x H (mm)	Order No.
 Shelf guard rail system set for 1 shelf	powder-coated sheet steel RAL 7035	40 x 719 x 80	35099
 Sump inliner for tray shelf	PP	310 x 700 x 30	36355
 Anti-slip rubber mat	grey	305 x 705 x 2	33575

Ventilation	Order No.
Extraction unit with exhaust air monitoring	14220
Extraction unit without exhaust air monitoring	14218
Recirculating air filter system with exhaust air monitoring for tall and underbench cabinets	39306

Can't find a suitable interior equipment package for your application?

V90.196.081.VDAC

Shelves/number	5	4
Distance 6 (mm)		
Distance 5 (mm)	260	
Distance 4 (mm)	285	290
Distance 3 (mm)	250	380
Distance 2 (mm)	250	285
Distance 1 (mm)	250	285

Quantity	Type of container	Container size
46	Aerosol cans	400 ml
21	Laboratory glass bottles	1 litre
8	Laboratory glass bottles	2.5 litres

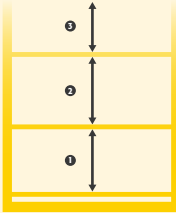
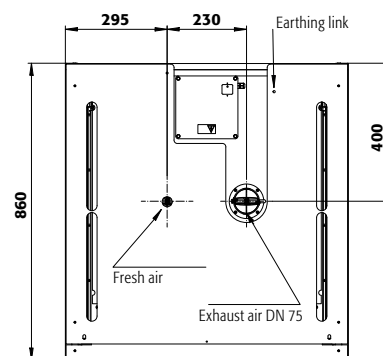
STAINLESS STEEL DOOR FRONT
V-LINE cabinets are available with high-quality stainless steel door fronts — ideal when maximum durability of the surface is required.



GUARD RAIL SYSTEM
Additional tilt protection for stored containers



Capture and filter hydrocarbon vapours with our recirculating air filter unit.
Benefit from the reliable technical ventilation of your safety storage cabinets without the need for complex connections to exhaust air ducts.



Further information from page 352



SAFETY STORAGE CABINETS ONLY PROVIDE RELIABLE PROTECTION ...

... for humankind, environment and property when they are maintained professionally! With the **ascos services** you are always on the safe side.

You can find our service tariffs from page 512

V-LINE | V-MOVE-90



Model V90.196.045.VDAC:0012
Order No. 35034-001-35101

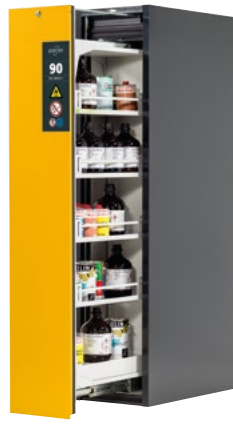

Model V90.196.045.VDAC:0013
Order No. 35085-040-35100





Model V90.196.045.VDAC:0012
Order No. 35034-005-35101

Technical data

External dimensions W x D x H	mm	449 x 860 x 1966
Internal dimensions W x D x H	mm	331 x 775 x 1750
Weight without interior equip.	kg	344
Air change 10 times	m ³ /h	5
Diff. pressure (air change 10 times EK5/AK4)	Pa	5
Max. load of drawers	kg	140
Power consump. in operation	W	50
Power consump. in standby mode	W	0,5
Nominal voltage	V	85-265



Main features

-  Space-saving design with high storage volume
-  Electronic vertical drawers for maximum ease of use
-  Visible storage

Model	Body colour	Door colour	Order No.
V90.196.045.VDAC:0013	anthracite grey RAL 7016	warning yellow RAL 1004	35085-040
		light grey RAL 7035	35085-041
		traffic red RAL 3020	35085-046
		gentian blue RAL 5010	35085-047
		stainless steel	35085-051
V90.196.045.VDAC:0012	light grey RAL 7035	light grey RAL 7035	35034-001
	laboratory white (sim. RAL 9016)	laboratory white (sim. RAL 9016)	35034-005

Interior equipment packages (can only be ordered in combination with the cabinet)	Material	Order No.
4x shelf, 1x perforated insert, 1x bottom collecting sump [V=12.5L]	powder-coated sheet steel RAL 7035	35100
5x shelf, 1x perforated insert, 1x bottom collecting sump [V=12.5L]	powder-coated sheet steel RAL 7035	35101
4x tray shelf [V=6.0L], 1x bottom collecting sump [V=12.5L]	powder-coated sheet steel RAL 7035	36111
5x tray shelf [V=6.0L], 1x bottom collecting sump [V=12.5L]	powder-coated sheet steel RAL 7035	36112

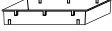
Accessories for these cabinet models:

Accessories	Material	W x D x H (mm)	Order No.
 Shelf guard rail system set for 1 shelf	powder-coated sheet steel RAL 7035	40 x 719 x 80	35099
 Sump inliner for tray shelf	PP	310 x 700 x 30	36355
 Anti-slip rubber mat	grey	305 x 705 x 2	33575

Ventilation	Order No.
Extraction unit with exhaust air monitoring	14220
Extraction unit without exhaust air monitoring	14218
Recirculating air filter system with exhaust air monitoring for tall and underbench cabinets	39306

Can't find a suitable interior equipment package for your application?

V90.196.045.VDAC

Shelves/number	5	4
Distance ⑥ (mm)		
Distance ⑤ (mm)	260	
Distance ④ (mm)	285	290
Distance ③ (mm)	250	380
Distance ② (mm)	250	285
Distance ① (mm)	250	285

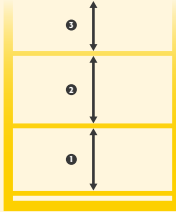

Storage capacities per drawer/type of container

Quantity	Type of container	Container size
46	Aerosol cans	400 ml
21	Laboratory glass bottles	1 litre
8	Laboratory glass bottles	2.5 litres

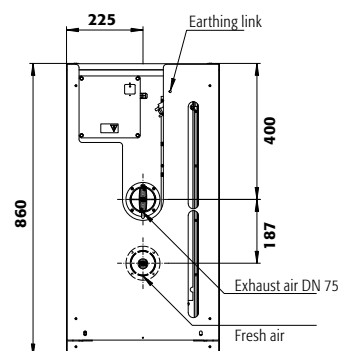

V-LINE

Safety storage cabinets for unrestricted storage of flammable hazardous materials in work areas in accordance with EN 14470-1 and TRGS 510

1

For the first time, the V-LINE MULTIRISK enables fire-protected storage of aggressive and toxic substances. Accordingly, the type 90 safety storage cabinet not only ensures safe storage of various hazardous substances but also provides maximum protection for users and rescue services in the event of a fire.



2

Both storage compartments can be used equally thanks to the sophisticated ventilation concept and the fire-protected and corrosion-resistant design. It is entirely up to you to decide which types of hazardous substances you store in the V-LINE MULTIRISK.



3

The materials used inside the cabinet, together with the technical ventilation system, provide a robust basis for the long service life of the cabinet. Each storage level is equipped with an insert tray made of chemical-resistant PE that can be removed easily for cleaning or in case of spills.



4

The space-saving storage solution with a high storage volume is ideal for installation next to fume cupboards.

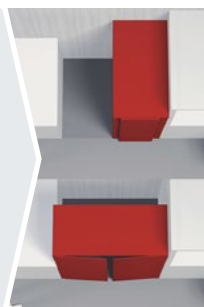

5

A sliding mechanism makes it easy to open the optional storage box that can be connected separately and is therefore ideal for toxic substances that need to be kept locked up.



6

Technical ventilation

Integrated air ducts ready for connection (DN 75) to a technical exhaust system can be used for the extraction of hazardous substances vapours. The potential formation of explosive atmospheres or harmful vapours is safely prevented.





- **Fire resistance of 90 minutes** (type 90), type-tested in accordance with EN 14470-1



- **GS-tested** (document EK5/AK4 09-10, ProdSG)



- Conformity in accordance with the requirements of **EN 16121** and **16122**
- Requirements and test methods for safety, strength, durability and stability.



- **Excellent products with special manufacturer warranty**
- Extended **manufacturer warranty of up to 10 years** in combination with an asecos service tariff
- Further information from page 512



V-LINE | V-CLASSIC-90





Model V90.196.060.MV.2VD:0012

Order No. 40285-005-40627

Technical data

External dimensions W x D x H	mm	600 x 860 x 1966
Internal dimensions W x D x H	mm	506 x 779 x 1750
Weight without interior equip.	kg	420
Air change 30 times	m ³ /h	20
Diff. pressure (air change 30 times)	Pa	11

Main features

-  Space-saving design with high storage volume
-  Vertical drawers with greater ease of use
-  Visible storage

Model	Body colour	Door colour	Order No.
V90.196.060.MV.2VD:0012	light grey RAL 7035 laboratory white (sim. RAL 9016)	light grey RAL 7035 laboratory white (sim. RAL 9016)	40285-001 40285-005

Interior equipment packages (can only be ordered in combination with the cabinet)	Material	Order No.
Left: 1x tray shelf with storage box, 3x tray shelf (V=4.2L), 4x perforated insert, 1x bottom collecting sump (V=11.5L) Right: 4x tray shelf (V=4.2L), 4x perforated insert, 1x bottom collecting sump (V=11.5L)	powder-coated sheet steel RAL 7035, PP grey, PE RAL 7035, grey	40498
Left: 4x tray shelf metal free (V=4.2L), 4x perforated insert, 1x bottom collecting sump (V=11.5L) Right: 4x tray shelf (V=4.2L), 4x perforated insert, 1x bottom collecting sump (V=11.5L)	PP grey, PE grey	40627

Accessories for these cabinet models:

Ventilation	Order No.
Extraction unit without exhaust air monitoring	14218
Extraction unit with exhaust air monitoring	14220

V90.196.060.MV.2VD:0012

Shelves/number	5	4
Distance 6 (mm)		
Distance 5 (mm)	285	
Distance 4 (mm)	255	
Distance 3 (mm)	290	
Distance 2 (mm)	290	
Distance 1 (mm)	250	

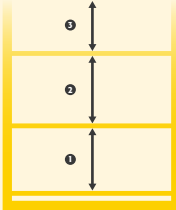

Storage capacities per drawer/type of container

Quantity	Type of container	Container size
46	Aerosol cans	400 ml
14	Laboratory glass bottles	1 litre
4	Laboratory glass bottles	2.5 litres

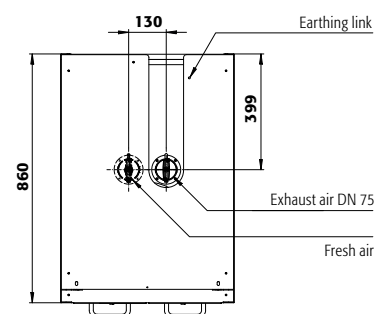

The asecos HazMat Guide

... we have collected the most important information on storing and handling hazardous materials safely. Order your free copy now: www.asecos.co.uk



Are you looking for an appropriate storage solution for hazardous materials?

Our optimised online product configurator helps you, step by step, to find the suitable safety storage cabinet.

Take the test: www.asecos-configurator.com



Discover our products in the virtual 3D showroom: www.asecos-showroom.com



SAFETY STORAGE CABINETS ONLY PROVIDE RELIABLE PROTECTION ...

... for humankind, environment and property when they are maintained professionally! With the **asecos services** you are always on the safe side.

You can find our service tariffs from page 512

По вопросам продаж и поддержки обращайтесь:

Алматы (727)345-47-04
Ангарск (3955)60-70-56
Архангельск (8182)63-90-72
Астрахань (8512)99-46-04
Барнаул (3852)73-04-60
Белгород (4722)40-23-64
Брянск (4832)59-03-52
Владивосток (423)249-28-31
Владикавказ (8672)28-90-48
Владимир (4922)49-43-18
Волгоград (844)278-03-48
Вологда (8172)26-41-59
Воронеж (473)204-51-73
Екатеринбург (343)384-55-89

Иваново (4932)77-34-06
Ижевск (3412)26-03-58
Иркутск (395)279-98-46
Казань (843)206-01-48
Калининград (4012)72-03-81
Калуга (4842)92-23-67
Кемерово (3842)65-04-62
Киров (8332)68-02-04
Коломна (4966)23-41-49
Кострома (4942)77-07-48
Краснодар (861)203-40-90
Красноярск (391)204-63-61
Курск (4712)77-13-04
Курган (3522)50-90-47
Липецк (4742)52-20-81

Магнитогорск (3519)55-03-13
Москва (495)268-04-70
Мурманск (8152)59-64-93
Набережные Челны (8552)20-53-41
Нижний Новгород (831)429-08-12
Новокузнецк (3843)20-46-81
Ноябрьск (3496)41-32-12
Новосибирск (383)227-86-73
Омск (3812)21-46-40
Орел (4862)44-53-42
Оренбург (3532)37-68-04
Пенза (8412)22-31-16
Петрозаводск (8142)55-98-37
Псков (8112)59-10-37
Пермь (342)205-81-47

Ростов-на-Дону (863)308-18-15
Рязань (4912)46-61-64
Самара (846)206-03-16
Санкт-Петербург (812)309-46-40
Саратов (845)249-38-78
Севастополь (8692)22-31-93
Саранск (8342)22-96-24
Симферополь (3652)67-13-56
Смоленск (4812)29-41-54
Сочи (862)225-72-31
Ставрополь (8652)20-65-13
Сургут (3462)77-98-35
Сыктывкар (8212)25-95-17
Тамбов (4752)50-40-97
Тверь (4822)63-31-35

Тольятти (8482)63-91-07
Томск (3822)98-41-53
Тула (4872)33-79-87
Тюмень (3452)66-21-18
Ульяновск (8422)24-23-59
Улан-Удэ (3012)59-97-51
Уфа (347)229-48-12
Хабаровск (4212)92-98-04
Чебоксары (8352)28-53-07
Челябинск (351)202-03-61
Череповец (8202)49-02-64
Чита (3022)38-34-83
Якутск (4112)23-90-97
Ярославль (4852)69-52-93

Россия +7(495)268-04-70

Казахстан +7(727)345-47-04

Беларусь +(375)257-127-884

Узбекистан +998(71)205-18-59

Киргизия +996(312)96-26-47

эл.почта: auj@nt-rt.ru || сайт: <https://asecos.nt-rt.ru/>